

G.A.L. HI-LO WELDING GAGE

MEASURES INTERNAL ALIGNMENT

of pipe after fit-up / alignment, cuts radiographic rejects.

Measures internal misalignment of pipe before and after tacking.

Measurements read in standard one side, and metric on the opposite side.

- Changes from standard to metric, simply remove gauge body, turn scales over and replace body
- Measure internal misalignment
- Measure fit-up gap
- Measure bevel on end preparation
- Measure the crown height of welds
- Measure fillet weld size
- Measure scribe line, socket welds
- Can be calibrated to NBS standard

Viewing Window

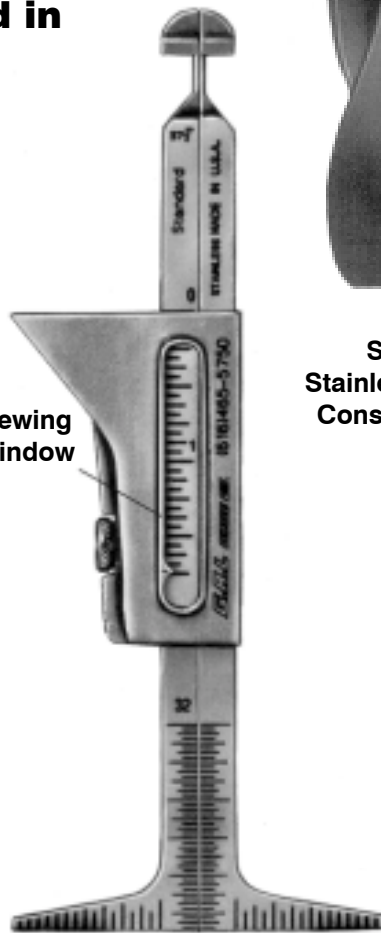

Solid Stainless Steel Construction

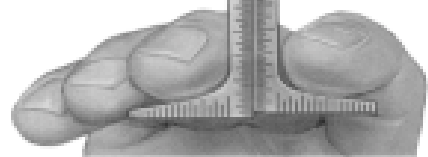
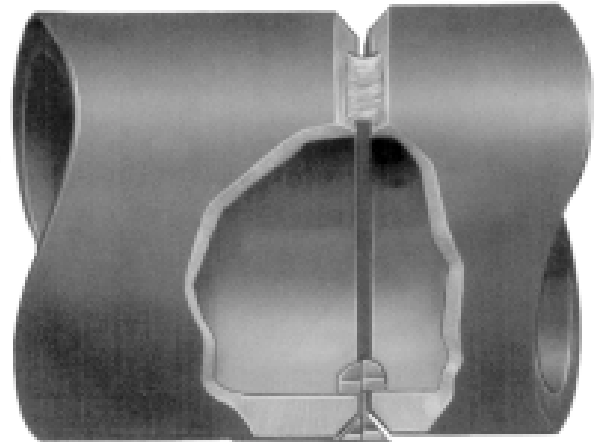

Part No.	Description
GAL-1	Standard & Metric Gauge



Measure internal mismatch, pipe wall.

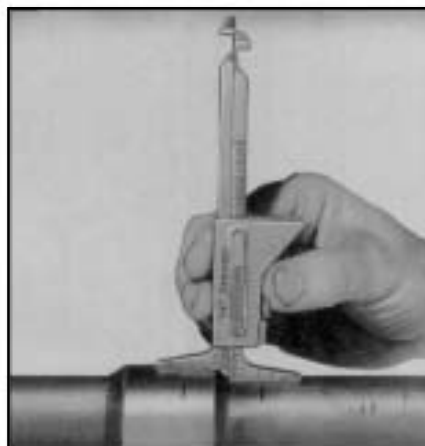

Measure scribe lines, weld fillet.

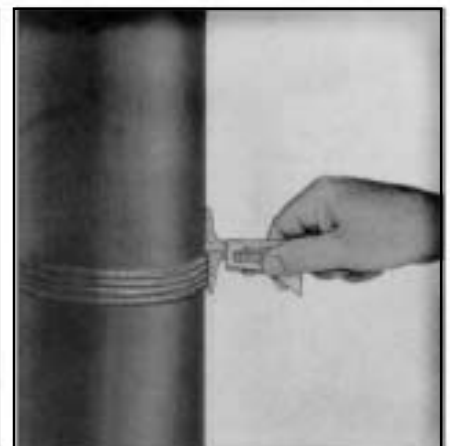

Measure crown height.

Satisfy fit-up codes ASME, ANSI, API & MILITARY

G.A.L. ECONOMY Single Purpose HI-LO Welding Gage

Available in
Standard or Metric

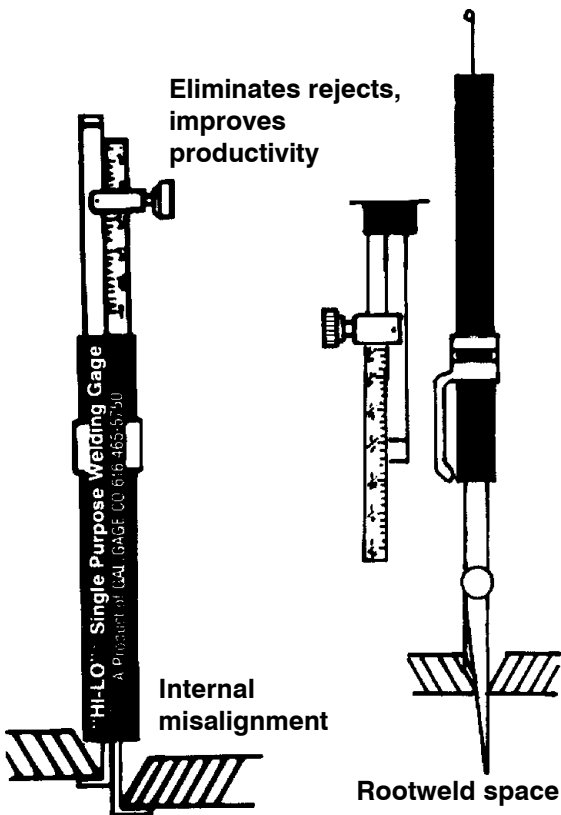

Part No.	Description
GAL-2	Standard Econo HI-LO Gauge
GAL-2M	Metric Econo HI-LO Gauge

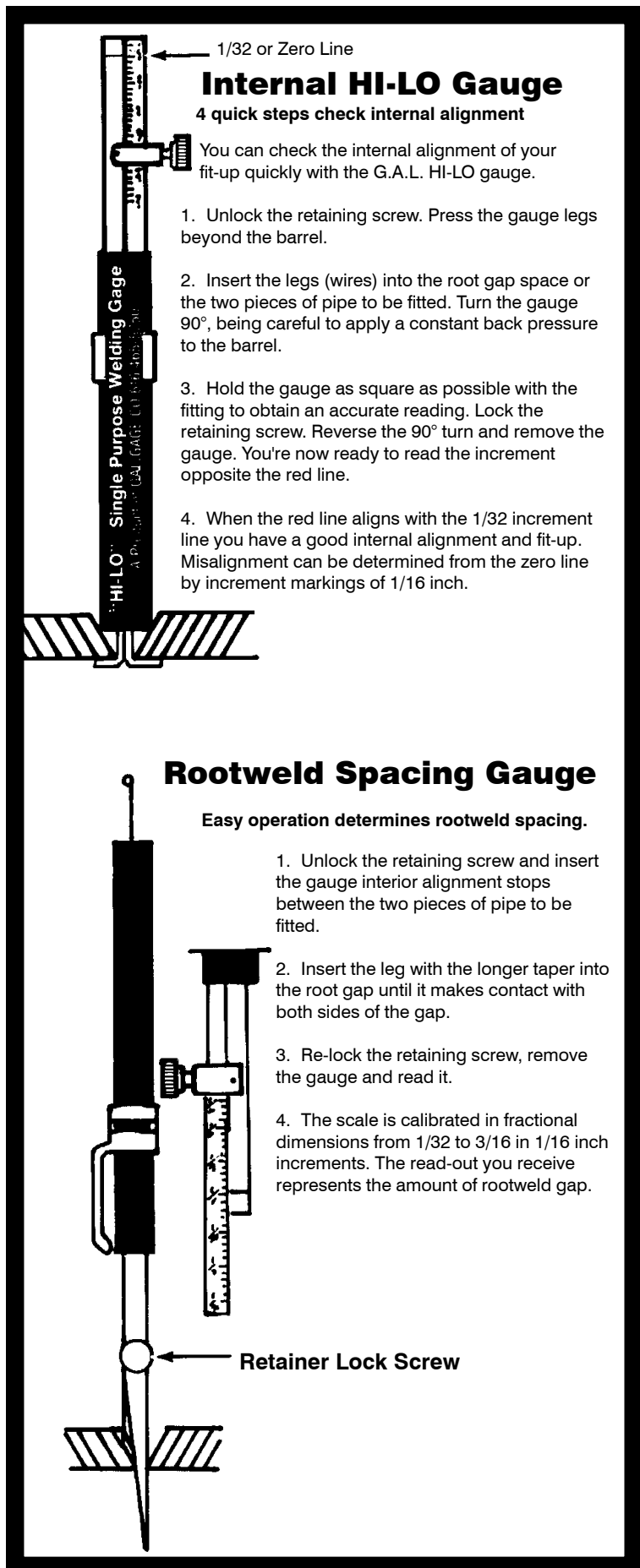

Internal HI-LO Gauge

4 quick steps check internal alignment

You can check the internal alignment of your fit-up quickly with the G.A.L. HI-LO gauge.

1. Unlock the retaining screw. Press the gauge legs beyond the barrel.
2. Insert the legs (wires) into the root gap space or the two pieces of pipe to be fitted. Turn the gauge 90°, being careful to apply a constant back pressure to the barrel.
3. Hold the gauge as square as possible with the fitting to obtain an accurate reading. Lock the retaining screw. Reverse the 90° turn and remove the gauge. You're now ready to read the increment opposite the red line.
4. When the red line aligns with the 1/32 increment line you have a good internal alignment and fit-up. Misalignment can be determined from the zero line by increment markings of 1/16 inch.

Rootweld Spacing Gauge

Easy operation determines rootweld spacing.

1. Unlock the retaining screw and insert the gauge interior alignment stops between the two pieces of pipe to be fitted.
2. Insert the leg with the longer taper into the root gap until it makes contact with both sides of the gap.
3. Re-lock the retaining screw, remove the gauge and read it.
4. The scale is calibrated in fractional dimensions from 1/32 to 3/16 in 1/16 inch increments. The read-out you receive represents the amount of rootweld gap.

Retainer Lock Screw

ADJUSTABLE FILLET WELD GAUGE

WITH UNEQUAL LEG MEASUREMENT FEATURE

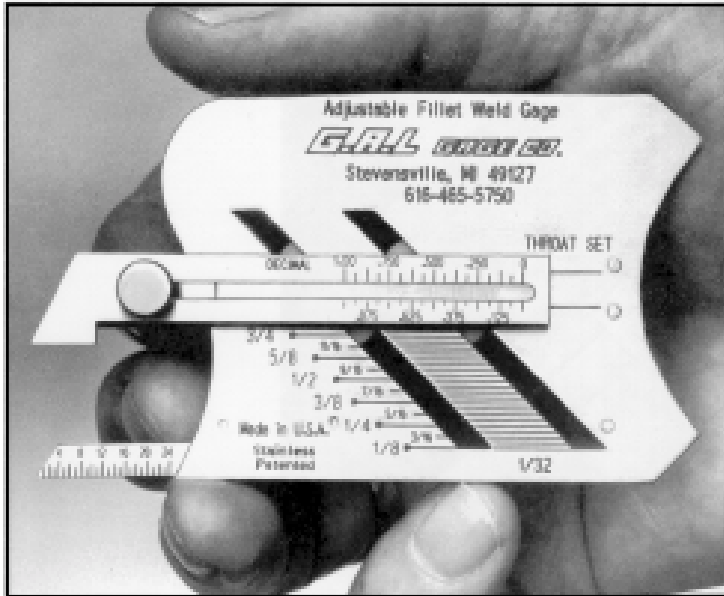

Measure any fillet weld to 1/32" accuracy with just one simple to use gauge.

Measuring fillet welds used to be a trial with complicated or inaccurate gauges. Not any more. Now you can measure fillet welds from 1/8" to 1" (with ±1/32" accuracy) with one economical, simple to understand gauge.

The G.A.L. Adjustable Fillet Weld Gauge uses an offset arm which slides at a 45° angle to make fillet weld length measurements. Simply adjust the arm until it touches the toe of the vertical leg. The gauge is calibrated to 32nds, with metric equivalents given, so you get more accurate readings. Four screws hold the offset arm in position for future adjustments.

This gauge also measures weld throat thickness to 1/16" by adjusting a pointer until it touches the centre of the weld. A thumb screw holds the pointer in position for future reference. If the weld is concave, more filler material can be added to build the weld throat up to standard.

G.A.L. Adjustable Weld Gauge measures both leg lengths and weld throat fillet weld thickness.

The G.A.L. Adjustable Fillet Weld Gauge is made of durable, rust resistant stainless steel. Its 2 1/4 x 3" slim design weighs only 1 1/2 oz., fits easily into a shirt pocket. And because there is just one gauge needed to make all measurements, the chance of losing essential fillet weld gauge blades is eliminated. Fumbling through seven different, inaccurate gauge blades is also eliminated.

Part No.	Description
GAL-3	Standard Gauge
GAL-3M	Metric Gauge

G.A.L. Adjustable Fillet Weld Gauge is easy to use.

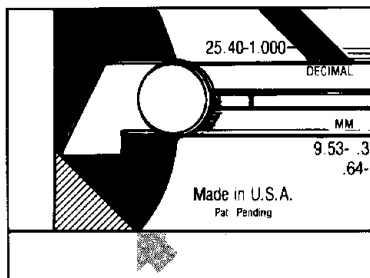

To measure fillet welds, place irregular curve edge flush to horizontal toe of weld so the straight edge is in line with the horizontal member.

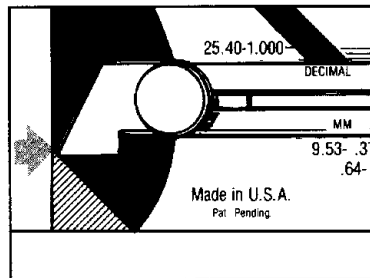

Adjust the offset arm up or down along the diagonal slots until the tip of the arm touches the top of the weld.

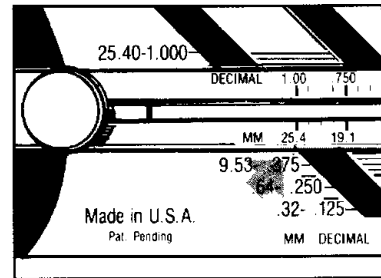

Read the weld size indicated. The increments are in 1/32" and 1/8" markings up to 1". All numerals are etched into the surface and filled for easier reading.

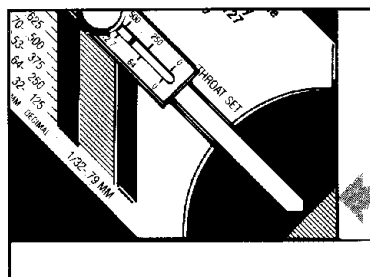

To measure weld throat thickness, place the 45° angle flush to the horizontal and vertical members. Loosen the thumb screw and slide the pointer until it touches the face of the weld.

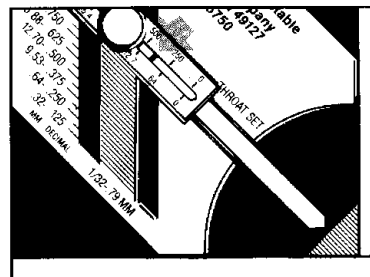

Tighten the thumb screw and read the measurement from the 1/16" calibrations along the pointer. A quick, sure way to find convex or concave welds and to correct them with additional filler material to meet standards.

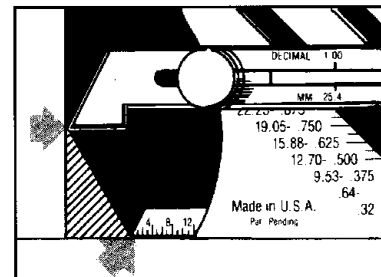

NEW! Measure unequal weld leg lengths by sliding the base measurement scale so it is flush to the horizontal toe of the weld. Adjust offset arm to touch top of weld. Add or subtract to obtain length of each leg.

BRIDGE CAM GAUGE

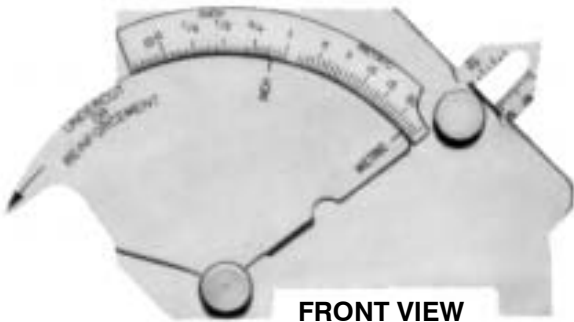

FRONT VIEW



BACK VIEW

Note:
Adjustable scale to
compensate for point wear.

STURDY

Gauge is made of stainless steel.

ACCURATE

Undercut depth or crown height
scale can be read to 1/32 inch.

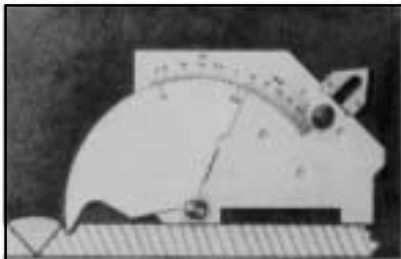

UNDERCUT

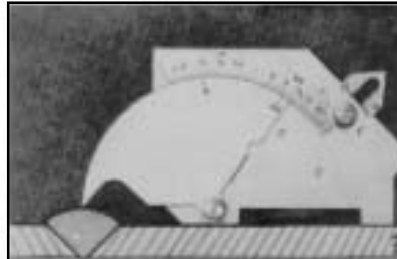

EXCESS WELD METAL

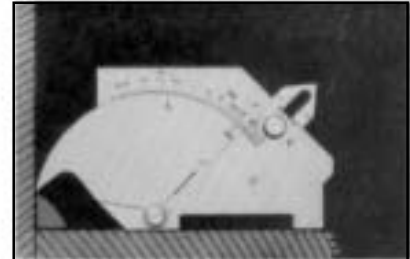

FILLET LEG LENGTH

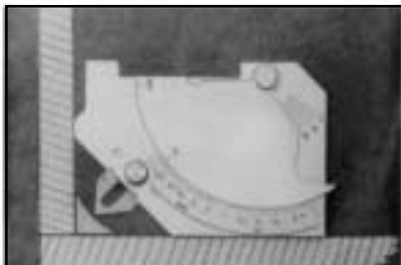

FILLET WELD THROAT

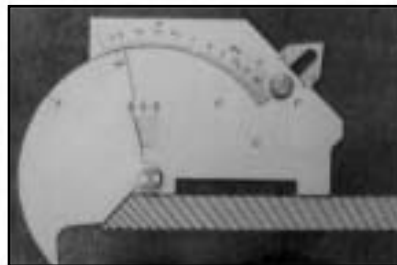

ANGLE OF PREPARATION

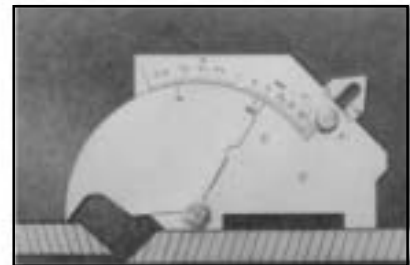

MISALIGNMENT

The following measurements are possible either in inches or millimetres.

Angle of preparation, 0° to 60°
Excess weld metal (capping size)
Depth of undercut
Depth of pitting

Fillet weld throat size
Fillet weld length
Misalignment (high-low)

General linear measurements up to 60 mm or 2 inches.

Part No.	Description
GAL-4	Standard and Metric Gauge

V-WAC™ GAUGE

Quickly determines if fillet welds meet NRC Visual Weld Acceptance Criteria for Structural Weldments

The V-WAC™ Gage easily and quickly checks the four essential measurements required for compliance with the NRC Visual Weld Acceptance Criteria. Checks undercut depth, porosity comparison, amount of porosity per linear inch and crown height. The V-WAC™ Gage can be purchased separately or as part of a complete set of seven Fillet Weld Gages that determine if your welds conform to specifications (See Page 7).

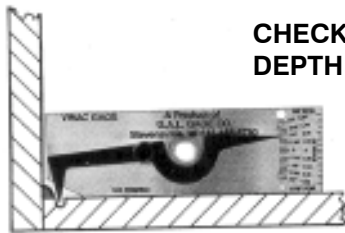

CHECKS UNDERCUT DEPTH

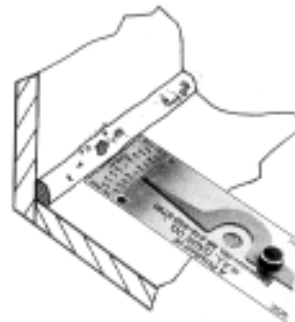

CHECKS AMOUNT OF POROSITY PER LINEAR INCH

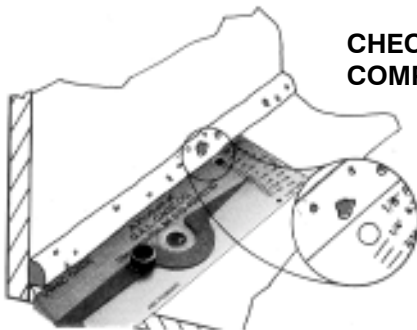

CHECKS POROSITY COMPARISON

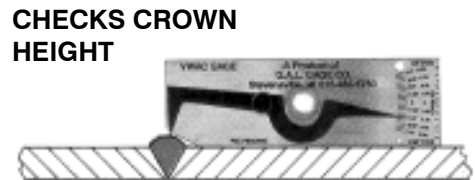

CHECKS CROWN HEIGHT

Features of the V-WAC™ Gage

ACCURATE

Undercut depth or crown height scale can be read to 1/32 inch.
Porosity comparison of 1/8 inch and 1/16 inch.
Linear gauge in 1/16 inch increments.

EASY TO USE

Pointer is easy to set and a locking screw holds it in position for later reference.
Figures and increments are etched into surface. They are easy to read and will not rub off.

FAST

All four required measurements are made with a single gauge.

STURDY

Gauge is made of stainless steel.

HANDY

Gauge is 1 1/4 inches by 4 inches, and can be easily carried in your pocket.

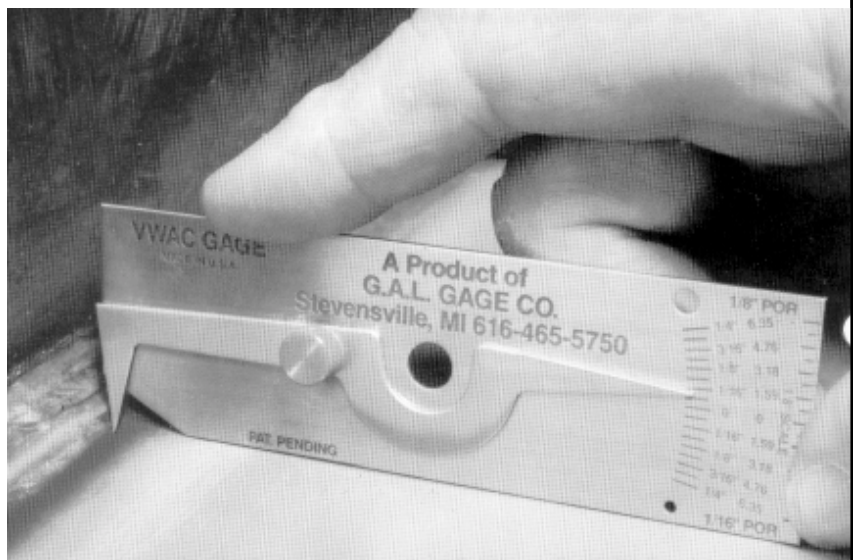

Part No.	Description
GAL-5	Gauge with 1/64" Tolerance
GAL-5-7	Gauge with WTPS Gauge and Block
GAL-5-8	Gauge Set
GAL-5-7-8	Gauge Set with WTPS Gauge and Block
GAL-5M	Metric Gauge with 1/64" Tolerance

AUTOMATIC WELD SIZE GAUGE

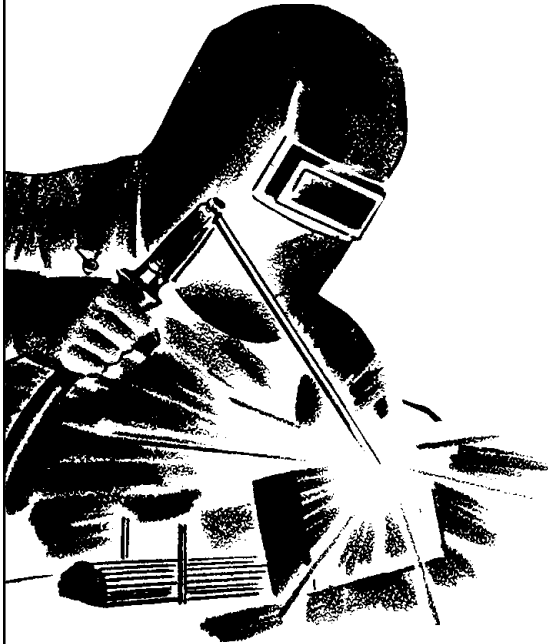

For Accurate Calibration of Butt and Fillet Type Welds

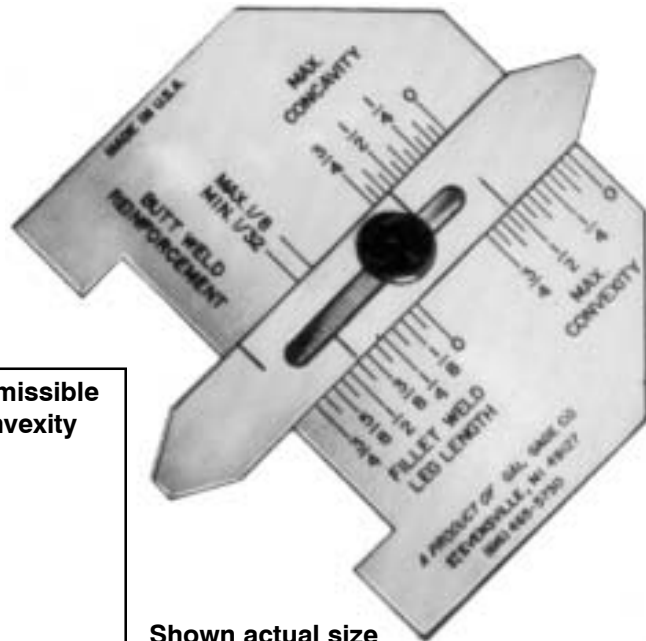

Shown actual size
(2 1/2" x 3")

With the new improved A.W.S. Gauge shown above it is possible to meet specifications of butt and fillet type welds. New redesigned instrument is pocket sized and easy to operate, new feature includes thumb screw which replaces old hard to operate rivet type.

Diagrams at left illustrate the ease with which welders and inspectors may accurately check sizes of convex or concave fillets as well as butt weld reinforcements.

The convexity and concavity sizes have automatically been predetermined in accordance with American Welding Society D1.1. Paragraph 3.6.

Instrument is precision built of stainless steel with dimensional readings chemically etched and filled for easier reading.

1. To Determine the Size of a Fillet Weld

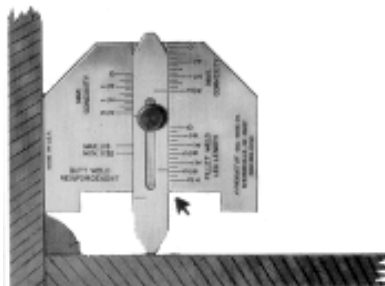

Place the gauge against the toe of the fillet weld and slide pointer out until it touches structure as shown. Read "Size of the Fillet Weld" on the face of gauge as indicated by arrow.

2. To Check the Permissible Tolerance of Convexity

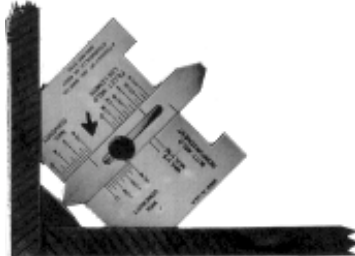

After the size of a convex weld has been determined, place the gauge against the structure and slide pointer until it touches face of fillet weld as shown. The maximum convexity should not be greater than indicated by "Maximum Convexity Scale" as indicated by arrow for the size of fillet being checked.

3. To Check the Permissible Tolerance of Concavity and Underfill

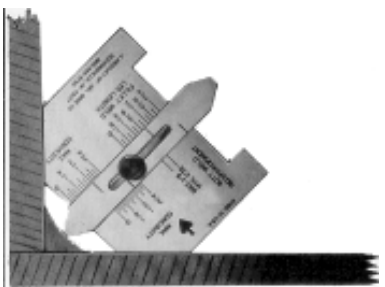

Place gauge against structure and slide pointer out until it touches the face of the fillet weld as shown. If the pointer does not touch as shown, the fillet requires additional weld metal.

4. To Check the Permissible Tolerance of Reinforcement

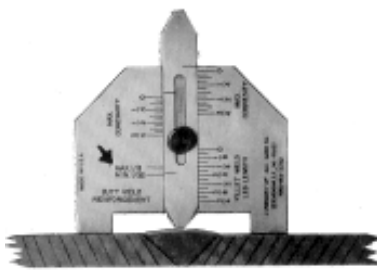

Place gauge so that reinforcement will come between legs of gauge and slide pointer out until it touches the face of weld as shown.

Part No.	Description
GAL-6	Standard Gauge
GAL-6M	Metric Gauge

W.T.P.S. Gauge with Calibration Block

How do you measure undercut .010 deep?

American Welding Society Structural Welding Code D 1.1 Paragraph 9.25 Quality of Welds 9.25.1.5 "Undercut shall be no more than .010 in. (0.25 mm) deep when the weld is transverse to the primary stress in the part that is undercut."

From G.A.L. Gage, Co. W.T.P.S. Gauge is precision made from stainless steel all marking and dimensions are chemically etched for ease and clarity when reading.

Gauge set comes with a precision ground calibration block as shown below, each block has been surface ground to .0005 tolerance for exceptional accuracy.



Part No. GAL-7
Description Standard Gauge



Gauge is made of stainless steel

G.A.L. Fillet Weld Gauge

Accuracy Guaranteed
New Manufacturing Process Allows This
Unsurpassed Accuracy of ±.005

The G.A.L. Fillet Weld Gauge allows fast, accurate measurement of eleven (11) fillet weld sizes: 1/8, 3/16, 1/4, 5/16, 3/8, 7/16, 1/2, 5/8, 3/4, 7/8, and 1", and their metric equivalents, to determine weld sizes, either concave or convex.

Each gauge blade is made of 1-1/4" x 4" cold rolled stainless steel to resist rust and bending. Blades are deburred to remove rough edges. All sizes and numerals are engraved into the surface for easier reading. The set of seven blades comes in a handy 2" x 4 1/2" pocket case weighing only 4 oz.

Knurled nut holds set together

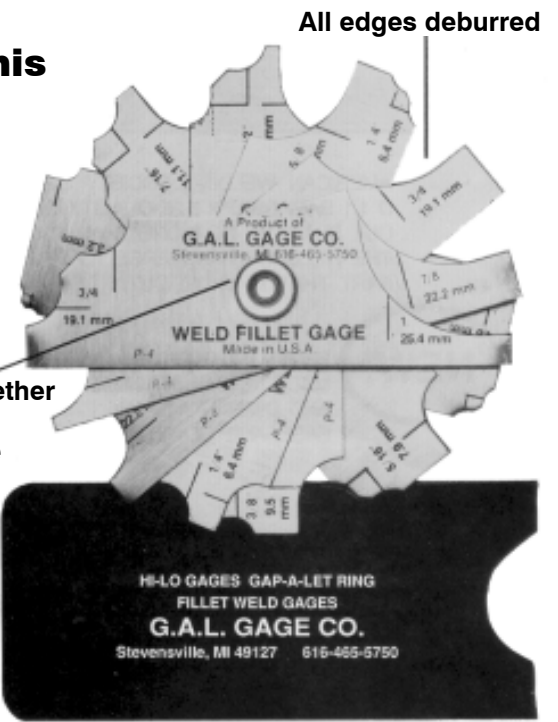

Handy Pocket Case

G.A.L. Fillet Weld Gauge is easy to use

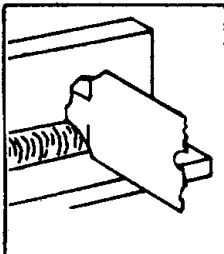

Gauge blade must be flush to the base material with the tip touching the vertical member. Use the single arc corners for measuring CONVEX welds. Use the double arc corners for determining if the welds are concave, (undersize). If they are, more filler material is required to build weld throat to the size where the tip between the double arcs touch.

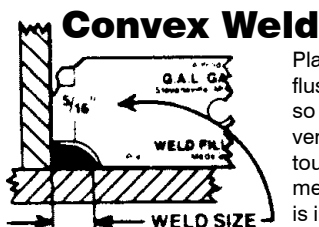

Convex Weld
Place single arc edge flush to base material so blade tip touches vertical member. If tip touches the vertical member, the weld size is indicated.

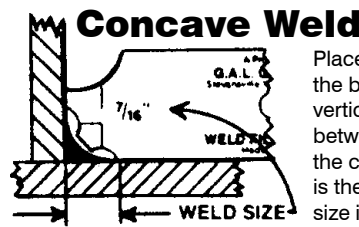

Concave Weld
Place double arc edge flush to the base material so tip touches vertical member. If the tip between the double arc touches the centre of the weld, the weld is the profile desired and is the size indicated.

Part No. GAL-8
Description Standard & Metric Gauge
GAL-8A Gauge w/ Markings Both Sides

G.A.L. Weld Gauge / Calculator

**NEWLY
REDESIGNED**

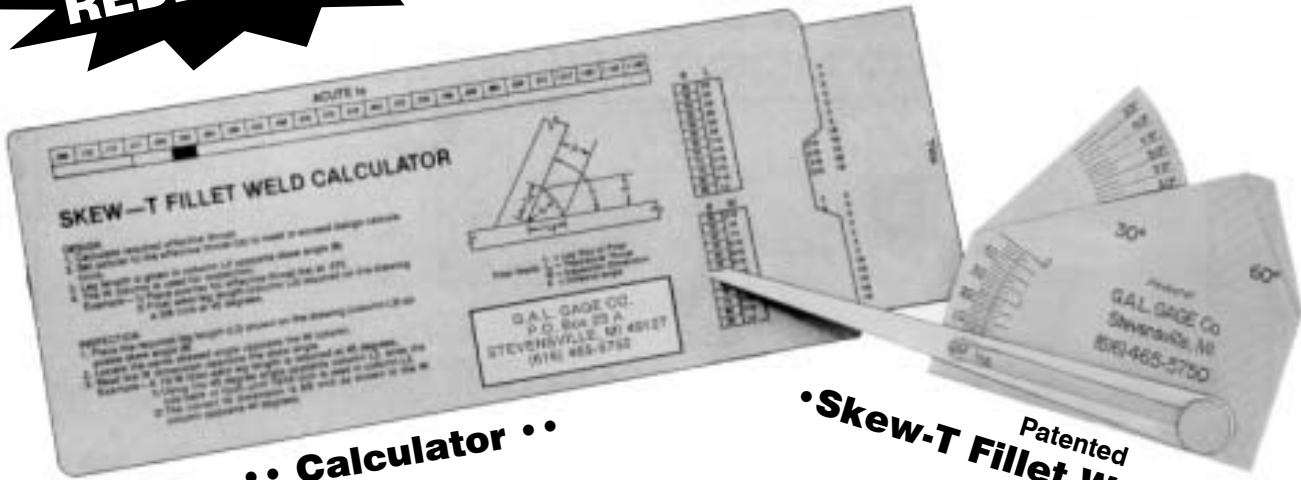

•• Calculator ••

Patented
• Skew-T Fillet Weld Gauge •

A handy compilation of mathematical relationships between leg length, throats, skew angles and inspection dimensions. A must for designers and inspectors. The perfect companion to the GAL Weld Gauge.

Replaces all other sets of gauges to measure fillet or groove welds in skewed members or members at 90 degrees.



**Gauge with
Pointer Retracted**



**Checking Angle of
Vertical Member**



**Gauge with
Pointer Extended**



Acute

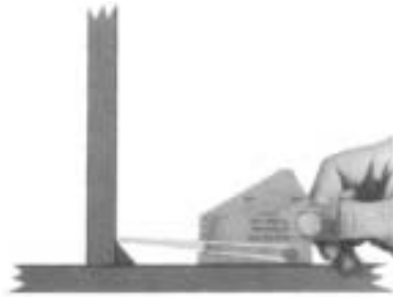

90 Degrees



Obtuse

Part No.	Description
GAL-9A	Weld Gauge Standard and Metric
GAL-9B	Weld Calculator Standard and Metric
GAL-9C	Weld Gauge and Calculator Standard and Metric

Pre Inspection Pocket Fillet Weld Gauge

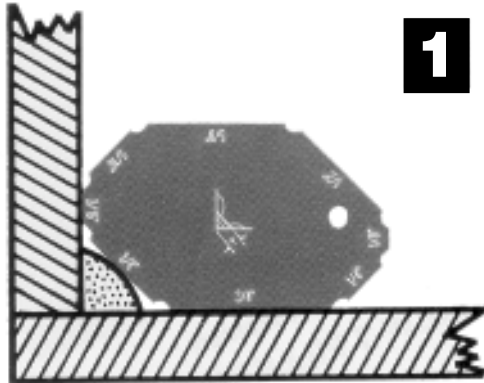

Measures Throat
(Allowable Convexity)

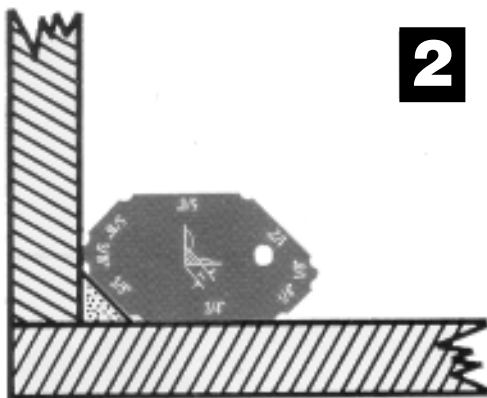

Measures Throat
(Theoretical)

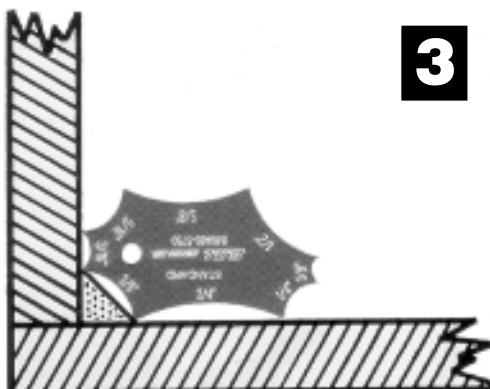

Measures Leg Length

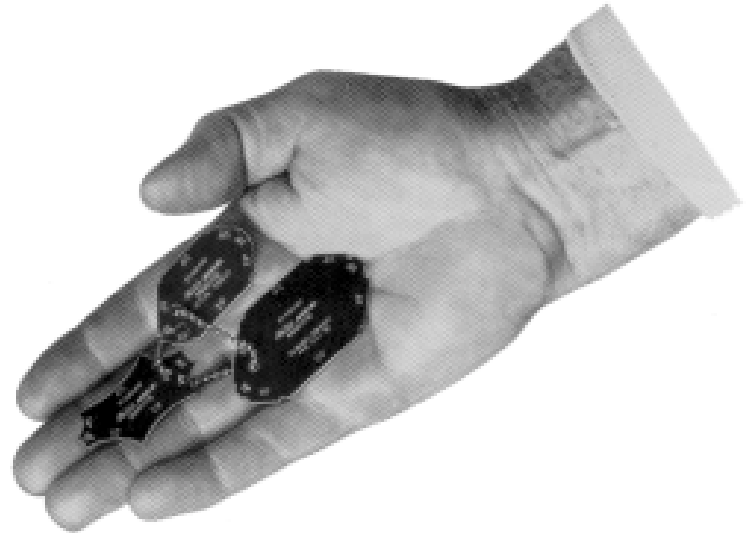

- New Pocket size — Measures 8 size fillets
- Check Leg Length, Throat Size, plus Allowable Convexity
- All increments permanently engraved
- Available Standard and Metric
- Each welder can carry set for pre-inspection
- Handy key ring holds set together
- Material Anodized Aluminum

Part No.	Description
GAL-10	Standard Gauge
GAL-10M	Metric Gauge

Special Gauge Section

Gauges Made on Special Order

- Custom gauges fabricated to your design or ours
- Tolerances to your specification, logos and identification permanently engraved, quick turnaround
- Automotive
- Military
- Aerospace

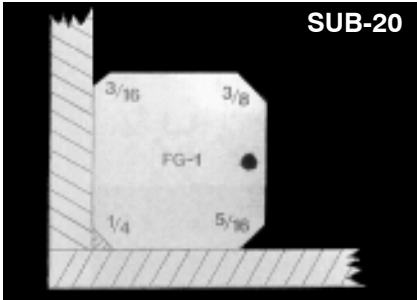

Special Design Fillet Gauge

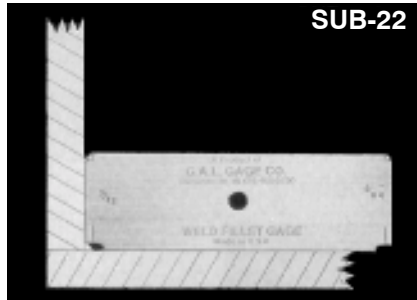

Small Tolerance Fillet Gauge



Special Fillet Gauge
Leg Length Only

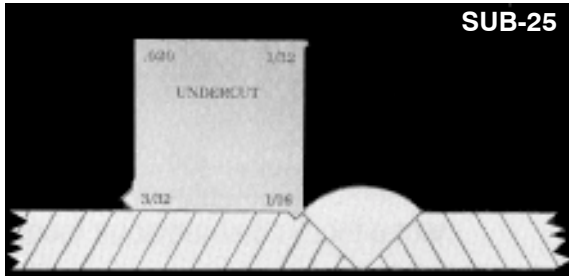

Special Undercut Gauge

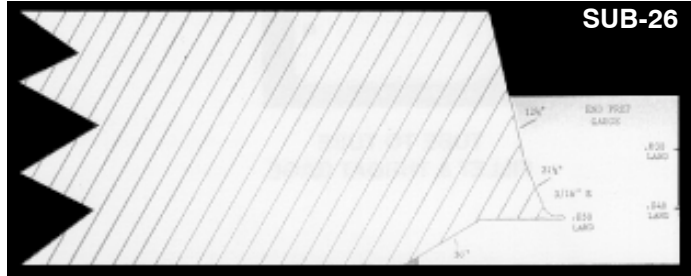

End Profile Gauge - Pipe

Taper Gauge

Part No.	Description
SUB-20	Special Design Fillet Gauge
SUB-22	Small Tolerance Fillet Gauge
SUB-23	Special Fillet Gauge
SUB-25	Special Undercut Gauge
SUB-26	End Profile Gauge
SUB-28	Taper Gauge

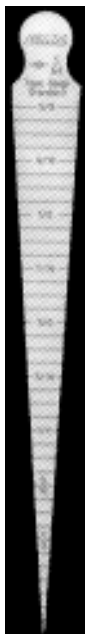

SUB-28
1/32 TO 5/8

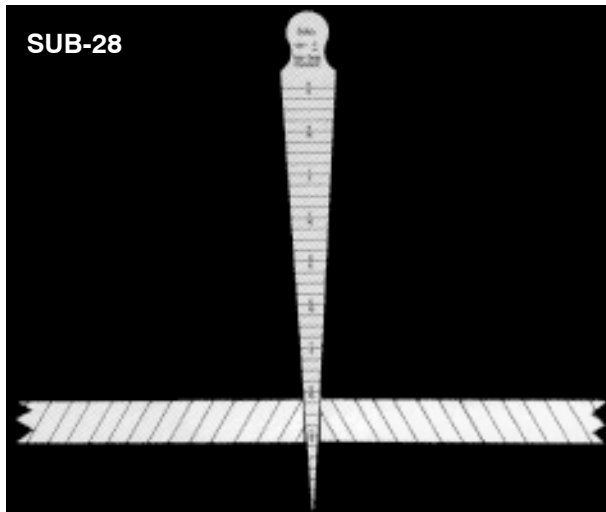

Check Plate Fit-Up

Front Side - Standard
Back Side - Metric

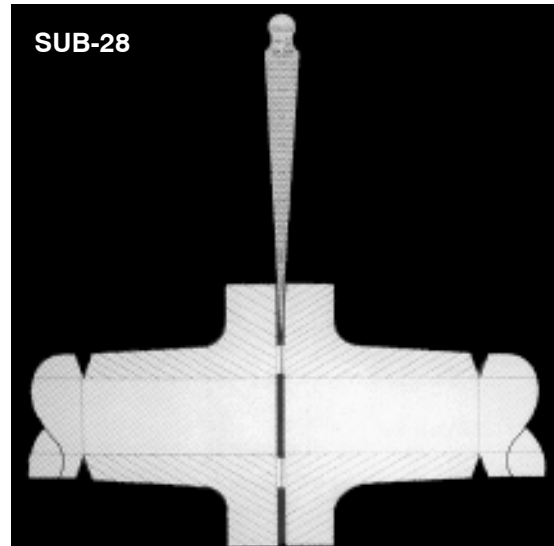

Check Flange Fit-Up

Combination 0" - 10" Dial / Pit Depth Gauge

- Measuring range 0 - 10"
- Graduations .001"
- Accuracy meets or exceeds federal specifications
- Continuous dial for 1/2" travel
- Revolution counter
- Uniform pressure over full range of travel
- Complete with 6 extension rods in fitted case
- Micro probes for small diameter pits .062 to .025
- Interchangeable bases



Gauge shown with welding base and .062 microprobe attached

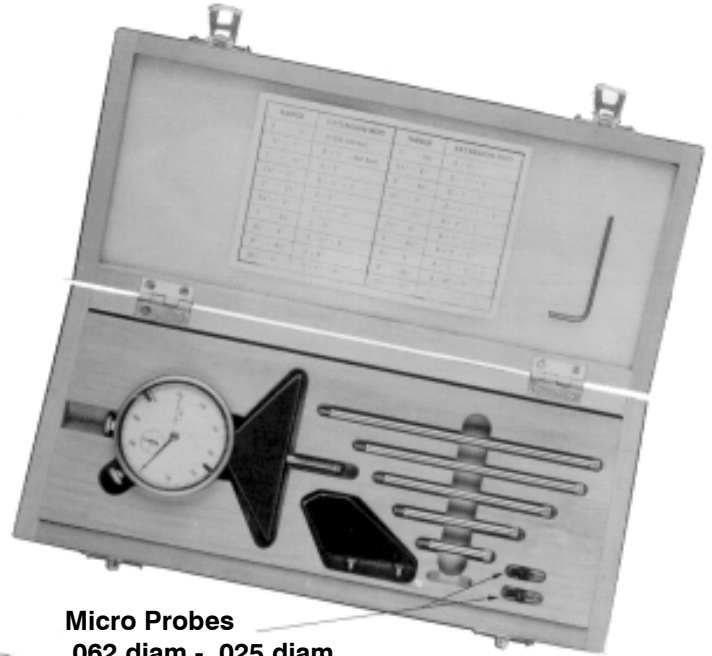

Micro Probes .062 diam - .025 diam

Measures pits, arc strikes, gouges, etc.



This kit was designed for the Quality Control department in the welding industry for pipe, structural, etc., to be used where extreme accuracy is required in determining depth of pits, gouges, undercut, crown height, etc.

Simply change bases and it can be used as a normal depth gauge.

Part No.	Description
GAL-13	Standard Gauge



Measures Undercut Socket Weld

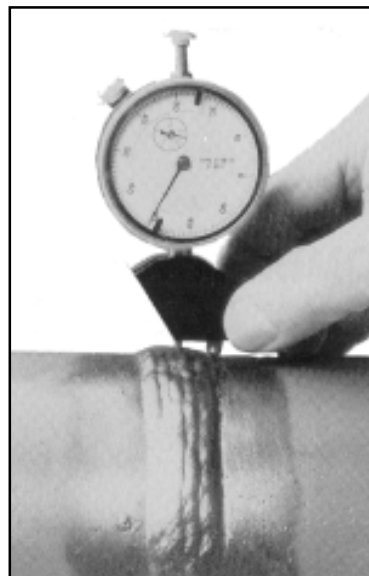

Measures Undercut Butt Weld

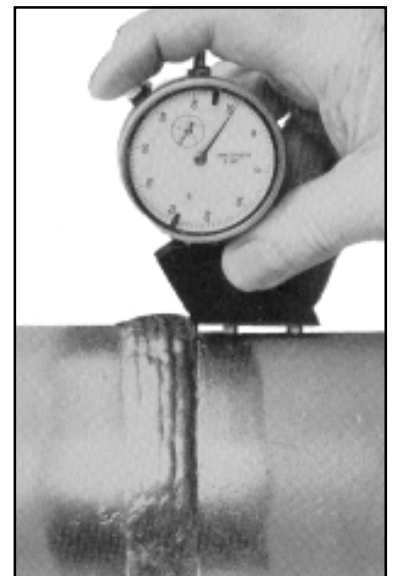

Measures Crown Height Butt Weld

Mini Sub Gauge

NEW

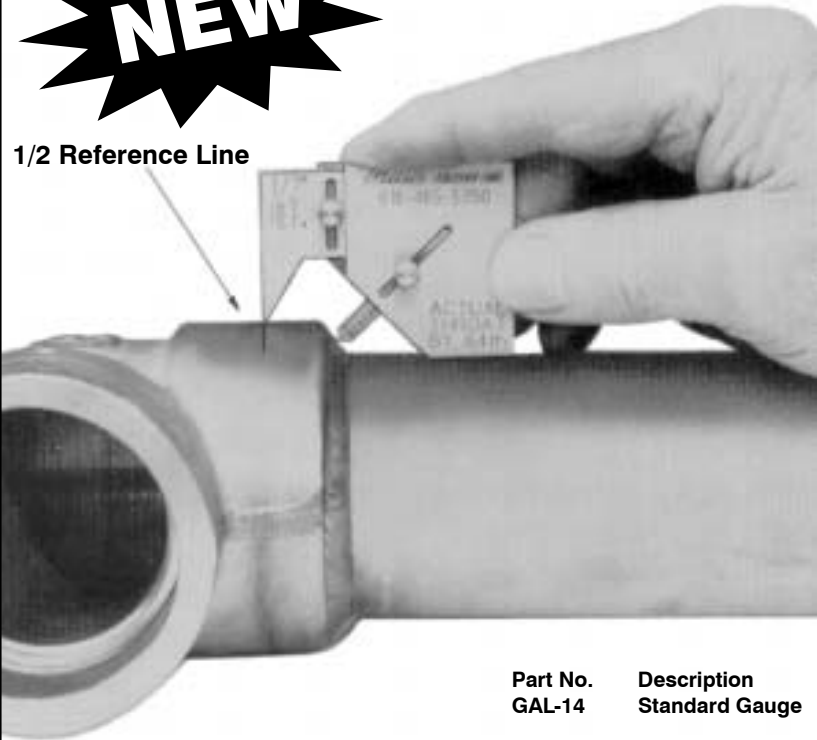

Sliding Pointer for Different Pipe Schedules

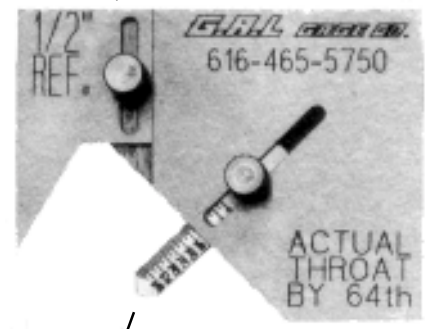

Sliding Pointer for Throat Measurement

Part No.	Description
GAL-14	Standard Gauge

Mini Fillet Weld Keys

NEW

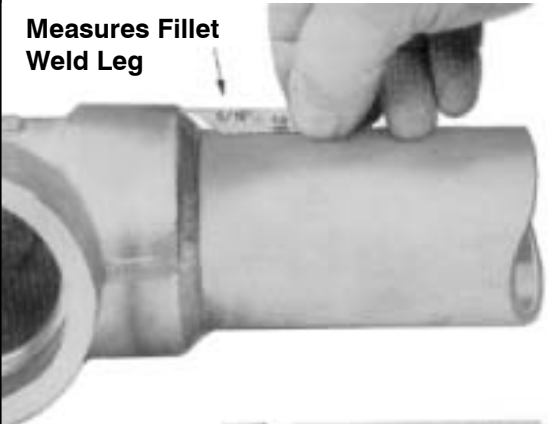

Measures Fillet Weld Leg

- All gauges are stainless steel
- 11 Different sizes in standard and metric equivalents
- Set comes with handy keychain

Part No.	Description
GAL-16	Standard & Metric Gauge

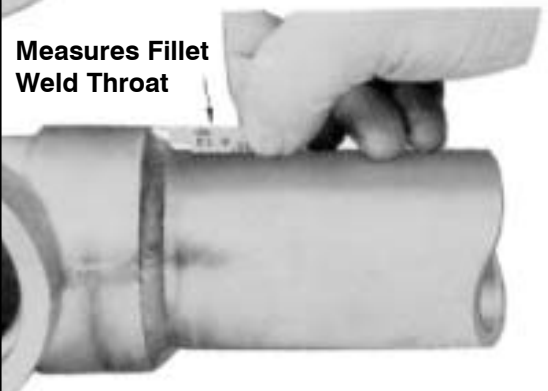

Measures Fillet Weld Throat



Welders, CWI® Inspectors, Instructors Kits

Complete kits featuring popular G.A.L. Gage gauges. Everything you need for complete weld inspections, in a convenient carrying case.

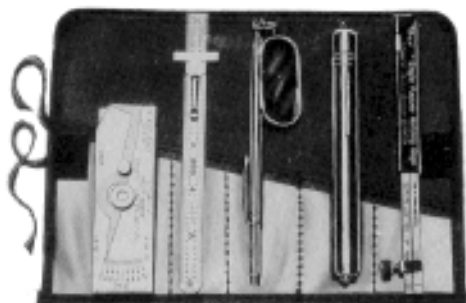

Measures 9" x 6½" open
6½" x 4¼" wrapped up
Fits in Pocket

Wrap-Around Pouch

Kit Includes:

- V-Wac Gauge (GAL-5)
- Econo Hi-Lo Gauge (GAL-2)
- 6" General Scale
- Telescoping Mirror
- Pen Light

Part No.	Description
GAL-12W	Wrap-Around Pouch Kit



Measures
13" x 8" x 3"

Medium Size Kit

Kit Includes:

- V-Wac Gauge (GAL-5)
- AWS Gauge (GAL-6)
- HI-LO Gauge (GAL-1)
- Micrometer with Ball
- Telescoping Mirror
- 6" Starrett Scale
- Magnifier
- Sturdy Protective Case

Part No.	Description
GAL-12M	Medium Size Kit

Brief Case Kit

Kit Includes:

- V-Wac Gauge (Gal-5)
- Fillet Weld Gauge (GAL-8)
- WTPS / Block (GAL-7)
- Bridgcam Gauge (GAL-4)
- Economy HI-LO Gauge (GAL-2)
- HI-LO Gauge (GAL-1)
- AWS Gauge (GAL-6)
- Skew-T Fillet Weld Gauge w/ Calculator (GAL-9C)
- Adj Fillet Weld Gauge (GAL-3)
- 6" Starrett Scale
- Telescoping Mirror
- Micrometer with Ball
- Magnifier
- Brief Case with Lock and Key

Part No.	Description
GAL-12B	Brief Case Kit



Measures
18" x 12½" x 3"

GAP-A-LET®

Socket Weld Contraction Rings

What is it?

Gap-A-Let is a split ring that is engineered and designed to give you a pre-measured 1/16" minimum gap for socket welds. Made from a certified stainless steel, Gap-A-Let resists corrosion from chemicals, radioactive materials and water.

Gap-A-Let's spring tension makes it fit tightly into all standard sized fittings from 1/4" to 5". (Non-standard sizes are available upon request). Once inserted into the fitting the Gap-A-Let ring becomes a permanent part of the joint. It will not rattle or vibrate even under extreme pressure.

Where is it used?

Designed for use on any socket weld application, Gap-A-Let rings are suitable for **power piping (nuclear, conventional), industrial hydraulics, welded railroad air brake piping, petrochemical plants, fertilizer plants, shipbuilding**, and the list goes on.

What does it do for you?

Socket welds that once took 15 minutes or more to fit-up now take just seconds. There is no measuring, scribing or re-measuring. Just pop the Gap-A-Let into the fitting and insert pipe into the fitting. Gap-A-Let socket weld contraction rings automatically set the required 1/16" minimum gap so you're ready to weld.

And because these rings are so easy to use, they eliminate some of the problems of socket welding. No longer is there the problem of error commonly caused by guessing the gap. Nor is there the need to scribe into hard-to-mark metal pipe walls with the danger of encroaching on minimum wall thickness. With Gap-A-Let rings quality control inspectors can concentrate on the **QUALITY OF THE WELD** and not spend all their time measuring for proper gapping. And since the costly problem of cracked welds due to improper gap is practically eliminated, your pipes can safely transport fluids the first time and every time.

A plus for piping engineers

Gap-A-Let rings help piping engineers determine end-to-end length of pipe without guessing. Constant, proper gap gives precise length whether in field run or fab shop assembly.

Three easy steps make proper 1/16" minimum gap socket welds in seconds

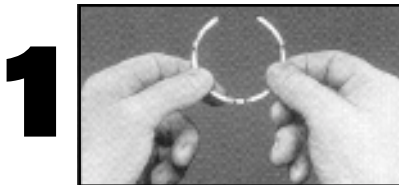

Fitter compresses Gap-A-Let® ring to fit into pipe fitting.



Fitter seats ring into fitting. Spring tension holds ring tightly in place, assuring no rattling or vibration even under extreme pressure. Ring actually becomes a permanent part of the joint.

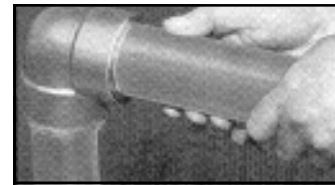

Fitter inserts pipe into fitting. Gap-A-Let® ring automatically assures the required minimum gap (1/16") to meet the code requirements of ANSI 31.1 Section III, ASME & military codes.

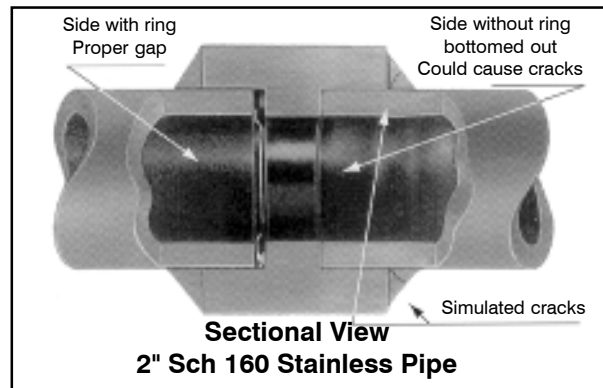

Get PROPER Socket Weld Fit-Up In One-Tenth The Time

Gap-A-Lets + Socket Welds

Why the gap between the pipe end and the internal shoulder of the fitting before welding?

The function of the gap is to permit thermal expansion of the pipe. Without the gap, the heat of welding can cause the pipe to expand at a faster rate than the fitting. If the pipe bottoms against the socket fitting, the thermal growth of the pipe strains the weld, possibly producing cracks in the root.

Failures have also been observed in socket welds subjected to thermal and mechanical cycling during service. The mechanism is similar to failure during welding. Rapid temperature changes cause the pipe to expand against the bottom of the fitting, straining and cracking the weld.

Construction and Military codes such as ANSI, ASME, NAVSEA-250-1500-1, MIL-STD-278 and MIL STD-22 permit socket welds to be used, provided a minimum 1/16" (1.6 mm) is established between the pipe end and socket prior to welding.



- Proper socket weld fit-up in one-tenth the time.
- Accurate 1/16" min. gap without time-consuming measuring, scribing and pull-out.
- Eliminate cracked welds resulting from improperly gapped joints.
- Meets military and commercial construction code standards.
- Patented-United States, Germany, United Kingdom, Japan and Canada.
- Sizes from 1/4" NPS to 5" NPS in stock for immediate shipment.
- Instrumentation tubing sizes 3/8" to 2".
- Boiler tubing sizes as required.

Elevation

Elevation

Elevation

Note: Width designed for minimum pipe wall schedules listed in American Standard B36.10 - B36.19

Design Data

Commercial Construction Codes
ANSI, ASME
Military Std. NAVSEA - 250- 1500
Military Std. 278
Military Std. 22

Nominal Pipe Sizes 1/4"-3/8", 1/2"-3/4"		.088
Nominal Pipe Sizes 1" - 3 1/2"		.088 +.000 / -.005
Nominal Pipe Sizes 4" - 5"		.093

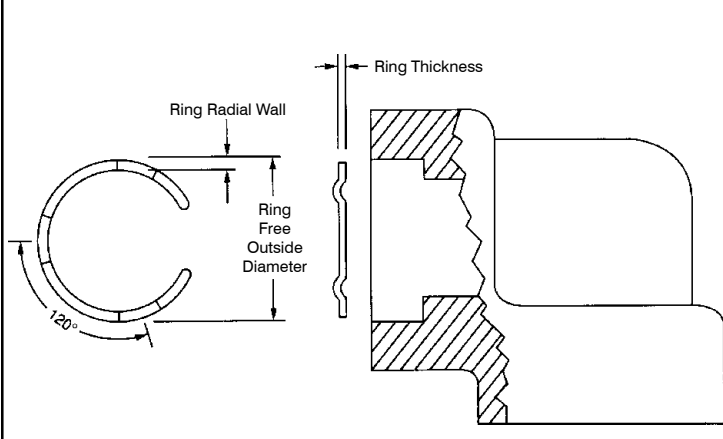

Standard GAP-A-LET Ring	Fitting	Ring Free Outside Diameter	Ring Radial Wall	Ring Thickness
1/4 NPS	.555	.600	.070	.025
3/8 NPS	.690	.730	.070	.025
1/2 NPS	.855	.880	.070	.025
3/4 NPS	1.065	1.110	.070	.025
1 NPS	1.330	1.385	.105	.030
1 1/4 NPS	1.675	1.780	.105	.030
1 1/2 NPS	1.915	2.020	.105	.030
2 NPS	2.406	2.580	.105	.030
2 1/2 NPS	2.905	3.010	.105	.030
3 NPS	3.500	3.885	.105	.030
3 1/2 NPS	4.000	4.150	.105	.030
4 NPS	4.500	5.110	.103	.040
5 NPS	5.563	5.880	.103	.040



**Get Proper Socket Weld Fit-Up In
One-Tenth the Time**

GAP-A-LET®

Socket Weld Contraction Rings

Patented

- Every socket weld gap, the proper 1/16" minimum required by ANSI 31.1 Section III, ASME US Navy & Military Codes
- No more scribe and pull out procedure
- No more measuring or guessing gap distance
- And no more cracked welds due to contraction of improperly gapped joints

Easy to Store, Easy to Distribute

Gap-A-Let socket weld contraction rings come in packages of 20 per re-sealable plastic bag - no messy case of loose rings ...no spilling of rings on floor while working. Just hand your welders and fitters the number of packages they need for the day and they're ready to make perfect, pre-measured socket welds to code. And the pre-counted contents make inventory and re-ordering easier, too. Helps prevent over- and under- stocking.



Every packet of Gap-A-Let socket weld contraction rings comes with a certified test report verifying the chemical analysis and physical properties of material shipped. While G.A.L. Gage Company does guarantee the test reports on the product material, any product can be misused, which in this instance could result in an improper weld. This certification and the use of Gap-A-Let ring in no way guarantees the quality, condition or durability of the weld. G.A.L. Gage Company will assume no responsibility for damage to the piping system or to component parts due to the use or misuse of this ring.

Part No.	Description
GAPxxx	Gap -A-Let Rings Pkg. of 20

(xxx = size of ring required ie. 0.25 for 1/4")